

# SENCOR®

STM 3780GG / STM 3787CH  
STM 3789SL



## EN ■ Food processor

*Translation of the original manual*

**READ CAREFULLY AND STORE FOR FUTURE USE.****General warnings**

- This appliance may be used by persons with physical, sensory or mental impairments or by persons with insufficient experience and knowledge, if they are properly supervised or have been informed about how to use the appliance in a safe manner and understand the potential dangers.
- This appliance may not be used by children. Keep the appliance and its power cord away from children.
- Children must not play with the appliance. Cleaning and maintenance performed by the user must not be performed by unsupervised children.
- In the event that the power cord is damaged, have it repaired at a professional service centre to prevent causing a dangerous situation. It is forbidden to use the appliance if it has a damaged power cord.

**Warning:**

Incorrect use may lead to injuries.

- Be especially careful not to injure yourself on the sharp cutting edges when handling the chopping blades, especially when removing the blades from the blending jar or smoothie jar, when emptying the container and when cleaning it.

- The surfaces of the appliance that come into contact with food must always be cleaned according to the instructions in this user's manual.
- Always turn off the appliance and disconnect it from the power socket if you will not be using it and if you will be leaving it without supervision, before assembly, disassembly, cleaning or moving it.
- Before replacing the accessories or accessible parts that move during use, turn the appliance off and disconnect it from the power supply.

#### **Electrical safety**

- Before connecting this appliance to a power socket, make sure that the voltage stated on its rating label corresponds to the voltage in your power socket.
- Connect the appliance only to a properly grounded socket. Do not use an extension cord.
- Do not connect and disconnect the power cord to and from the power socket with wet hands.
- Ensure that the power plug contacts do not come into contact with water or moisture.
- Do not disconnect the appliance from the power socket by pulling on the power cord. This could damage the power cord or the power socket. Disconnect the cord from the power socket by gently pulling the plug of the power cord.
- Do not place heavy items on the power cord. Make sure the power cord does not hang over the edge of a table and that it is not touching a hot surface or sharp objects.
- To avoid the danger of injury by electrical shock, do not repair the appliance yourself or make any adjustments to it. Have all repairs or adjustments of the appliance performed at an authorised service centre. Tampering with the appliance during the warranty period may void the warranty.
- Do not spray the appliance with water or any other liquid. Never wash it under running water or submerge it in water or another liquid.
- Always turn off the appliance and disconnect it from the power socket when you have finished using it.
- This appliance is not designed to be controlled using a programmed device, external timer switch or remote control.
- Only start the appliance after submerging the accessories into the container with the ingredients. To prevent food from splashing out, keep the attachments submerged in the container while the appliance is running.
- If food sticks to the attachments or the inside of the bowl, turn off the appliance and disconnect it from the power socket. Use a spatula to clean the attachments and the sides of the bowl.
- Avoid coming into contact with the rotating parts of the appliance. Do not place hands, forks or any other utensils into the bowl with the ingredients, and keep hair, clothing, etc. at a sufficient distance from the rotating parts of the appliance during use. If a fork or another utensil falls into the container while the appliance is running, immediately it off.
- Make sure that no hair, clothing or other items enter the feed tube of the meat grinder or grater while it is running. Do not put anything other than the ingredients that are to be processed into the feed tube.
- Never use your fingers or other items to push ingredients through the feed tube of the meat grinder or grater. For this purpose there is a pusher included as an accessory.
- Do not tilt open the multi-function head during operation.
- Be especially careful when handling hot liquids and foods. Hot steam or splashing hot foods and liquids may cause scalding. For reasons of increased safety, it is recommended to allow hot liquids and foods to cool down before processing them.
- If you have just processed hot foods, the removable attachments may be hot after they are used.
- Before attaching attachments to the appliance, removing or replacing them, ensure that the appliance is turned off and disconnected from the power socket.
- To prevent injury caused by sharp edges, be especially careful when handling the grinding blade of the meat grinder and the blade assembly of the blender. Increased attention must also be paid when emptying out the blending jar, when removing the blade assembly from the blending jar, when removing the grinding blade from the grinding chamber, and when cleaning the appliance.
- Do not attempt to grind bones, nut shells or other hard ingredients.
- Hot liquids up to a temperature of 80 °C may be processed in the stainless steel bowl. Be especially careful when handling hot liquids. Hot steam or splashing hot foods and liquids may cause scalding. Never start the blender without the lid properly seated in position. When processing hot liquids, do not remove the inner cap during operation. Do not touch the hot surface. Use the handle to carry the blending jar when it is hot.
- The maximum continuous operating time is 10 minutes. Do not exceed the maximum operating time of 5 minutes when in the kneading mode and do not exceed the maximum operating time of 2 minutes when using the blender. Before starting it again, allow the appliance to cool down for 30 minutes.

#### **Safety during maintenance**

- Allow the appliance to always fully cool down before cleaning it.
- Regularly clean the appliance after each use according to the instructions in chapter Maintenance and cleaning. Do not perform any maintenance on the appliance apart from the maintenance procedure described in chapter Maintenance and cleaning.
- Do not wash the multi-function head or stand under running water or submerge it in water or another liquid. The food processor is not designed to be washed in a dishwasher.
- The removable attachments are intended for short term contact with food (including beverages), i.e. max. 4 hours. To prevent damaging their surface, do not leave them submerged, for example in water for extended periods of time.
- Before storing the appliance, check that the multi-function head is tilted to the horizontal position.

A

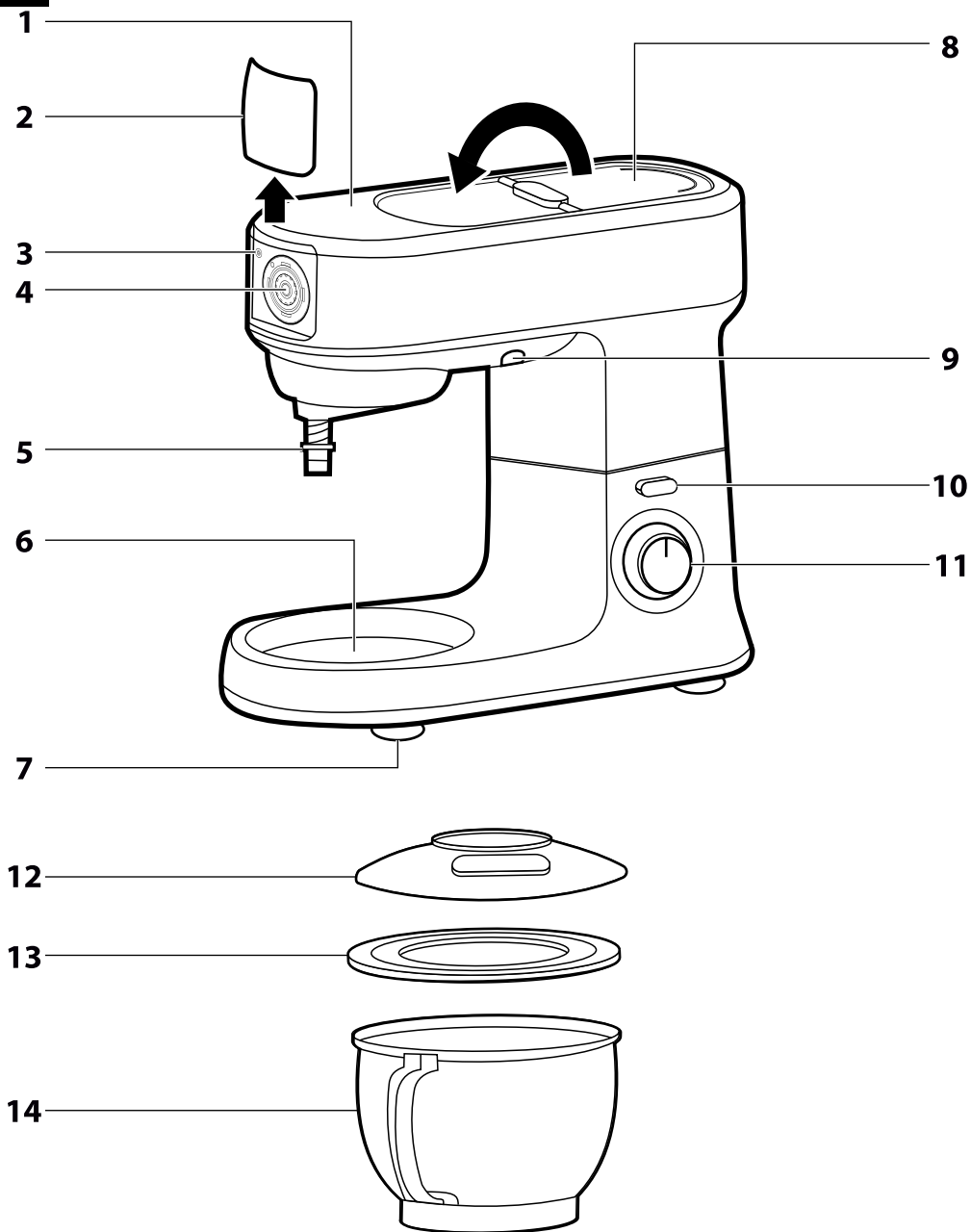

**B**

1



2

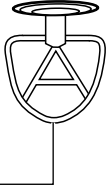

3



4

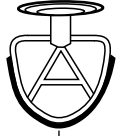

**C**

1

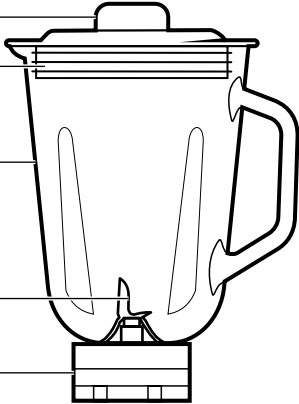

2

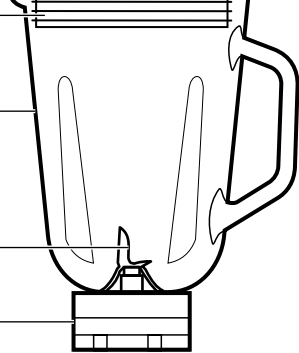

3

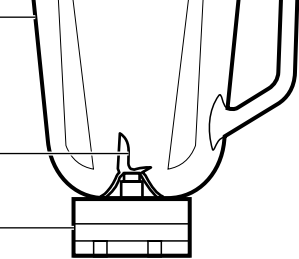

4

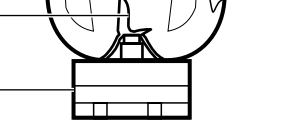

5

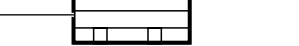

6

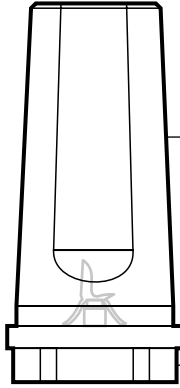

7



D

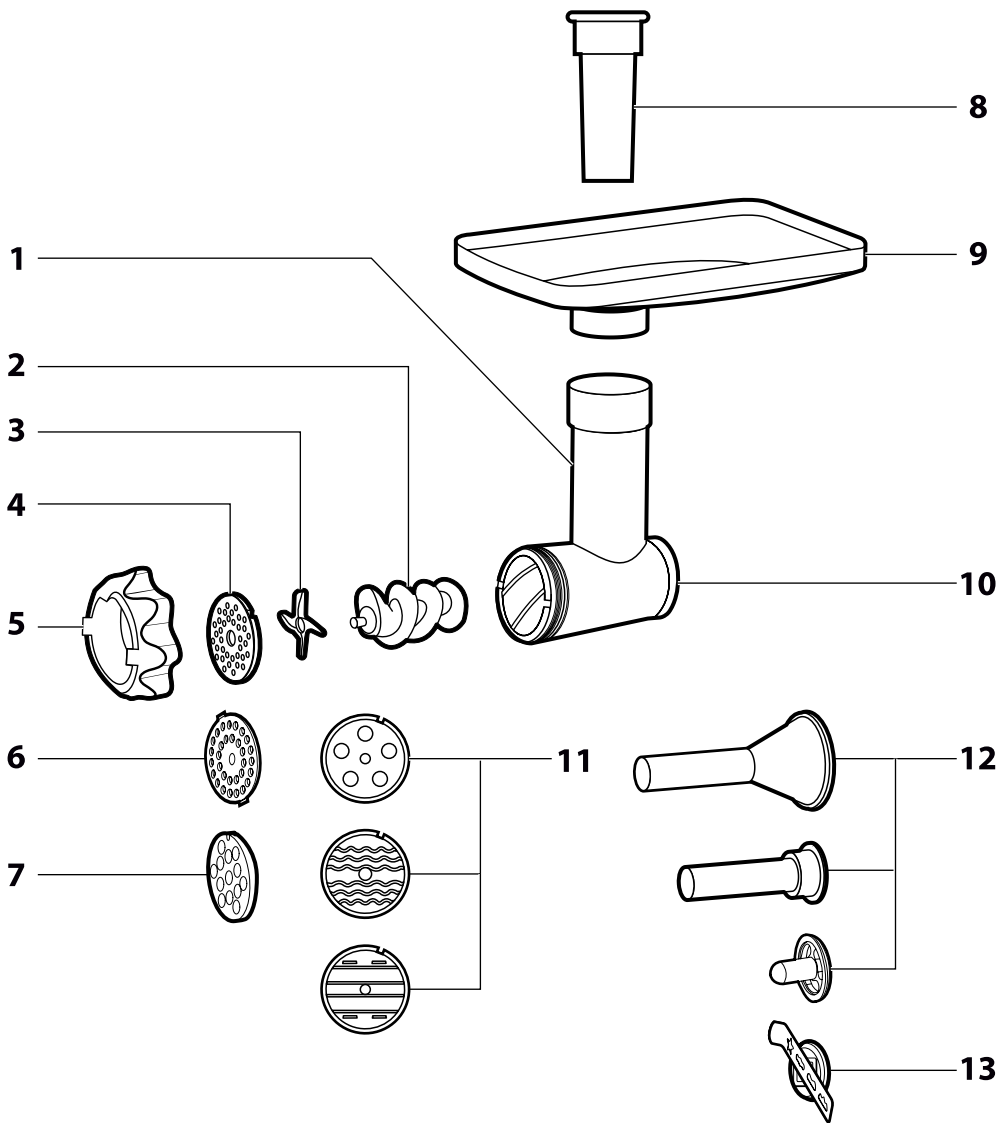

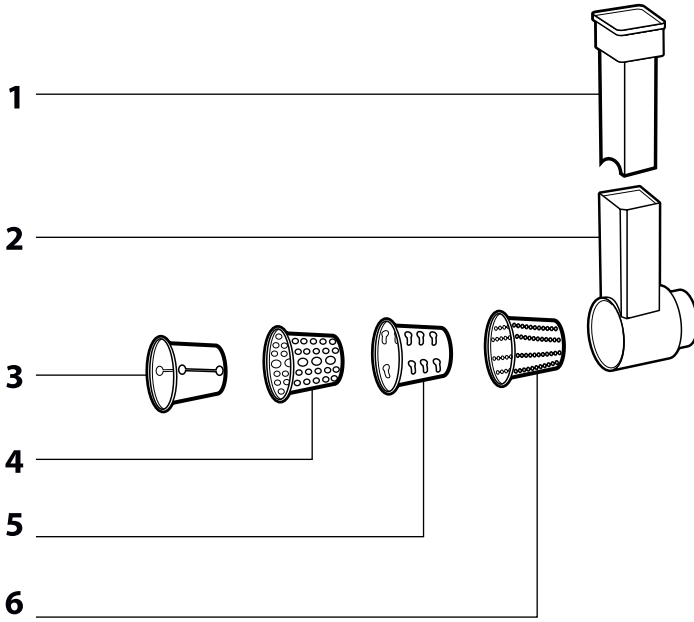
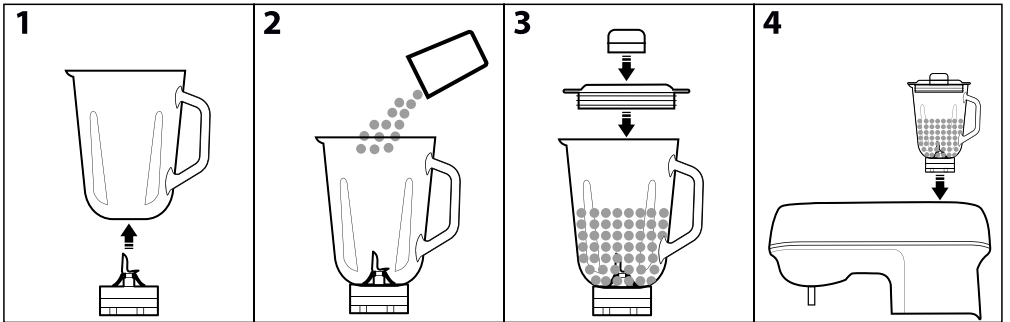
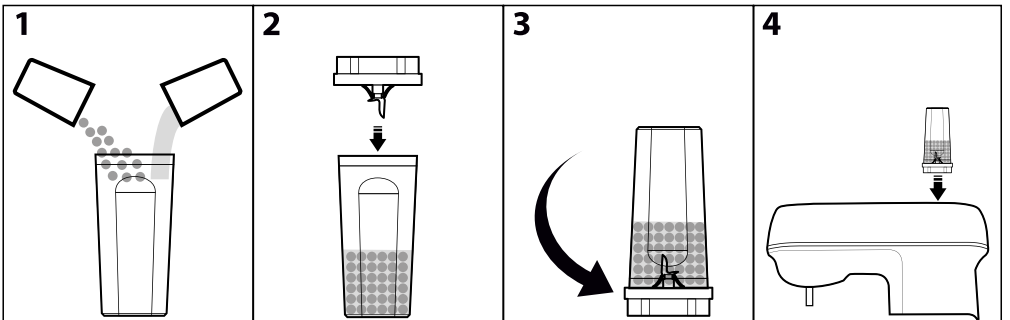
**E****F****G**

H

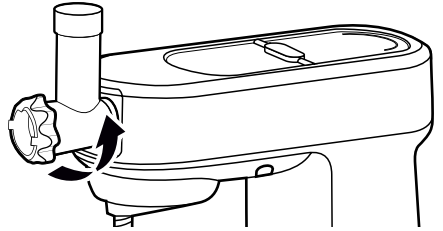
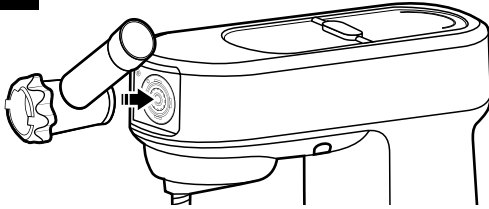

I

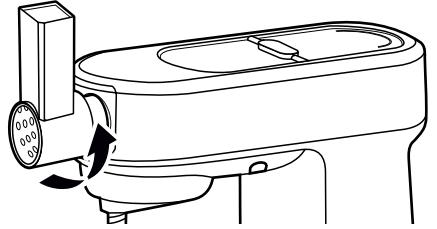
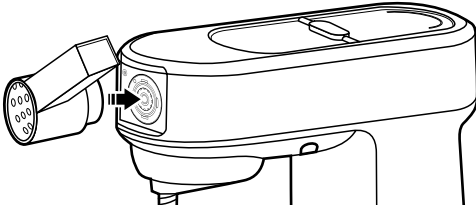





# EN Food Processor

## User's manual

### BEFORE FIRST USE

- Prior to using this appliance, please read the user's manual thoroughly, even in cases, when one has already familiarised themselves with previous use of similar types of appliances. Only use the appliance in the manner described in this user's manual. Keep this user's manual in a safe place where it can be easily retrieved for future use. In the event that you hand this appliance over to somebody else, make sure to also include this user's manual.
- We recommend saving the original cardboard box, packaging material, purchase receipt and responsibility statement of the vendor or warranty card for at least the duration of the legal liability for unsatisfactory performance or quality. In the event of transportation, we recommend that you pack the appliance in the original box from the manufacturer.
- Carefully unpack the appliance and take care not to throw away any part of the packaging before you find all the parts of the appliance.

### DESCRIPTION OF THE APPLIANCE AND ACCESSORIES

<b>A1</b> Tilt-out multi-function head	tilt-down button
<b>A2</b> Removable cover of the front meat grinder or grater attachment hub	<b>A11</b> Control knob with light - 0 (turned off, stand-by mode) - speed levels 1-2-3-4-5-6, - blender mode in blending jar 
<b>A3</b> Button for releasing the meat grinder from the attachment hub	- blender mode in smoothie jar 
<b>A4</b> Front attachment hub for meat grinder and grater	- light 
<b>A5</b> Fastening shaft for attachments	<b>A12</b> Transparent anti-splash cover with feed hole
<b>A6</b> Base for stainless steel bowl	<b>A13</b> Stainless steel bowl lid
<b>A7</b> Anti-slip feet	<b>A14</b> 5-litre stainless steel bowl for processing food
<b>A8</b> Tilt-open cover of the top blender attachment hub	
<b>A9</b> Light	
<b>A10</b> Multi-function head tilt-out and	
<b>B1</b> Balloon whisk	<b>B3</b> Kneading hook
<b>B2</b> Beater	<b>B4</b> Elastic beater
<b>C1</b> Inner cap	<b>C5</b> Base for mounting/removing the blender from the attachment hub
<b>C2</b> Outer lid with a hole for adding ingredients	<b>C6</b> 0.6-litre smoothie jar for nutritional drinks
<b>C3</b> 1.5-litre blending jar	<b>C7</b> Base for nutritional drink jar
<b>C4</b> Blade assembly	
<b>D1</b> Grinder	<b>D8</b> Pusher
<b>D2</b> Screw shaft	<b>D9</b> Hopper
<b>D3</b> Grinding blade	<b>D10</b> Grinding chamber
<b>D4</b> Fine grinding plate	<b>D11</b> Pasta making attachments
<b>D5</b> Screw ring	<b>D12</b> Sausage stuffer attachment
<b>D6</b> Medium grinding plate	<b>D13</b> Cookie maker with holder
<b>D7</b> Coarse grinding plate	
<b>E1</b> Pusher	<b>E4</b> Coarse grating cone
<b>E2</b> Grater	<b>E5</b> Potato grating cone
<b>E3</b> Slicing cone	<b>E6</b> Fine grating cone

### INTENDED USE OF THE APPLIANCE

- The food processor is intended and designed for processing a standard amount of food in the household. It is suitable for blending, beating, kneading, grinding and grating.

### BEFORE FIRST USE

- Before first use, thoroughly wash all parts that come into contact with food in hot water using neutral dishwashing detergent. Then rinse everything with clean water and allow to dry naturally or wipe dry thoroughly using a wiping cloth.



#### Attention:

Accessories **B1** to **B4**, the meat grinder **D1** and the grater **E2** are not intended for washing in a dishwasher. Other removable parts may be washed in a dishwasher. When washing the blade assembly **A21**, take special care to avoid injury on the sharp cutting edges.

- Use a lightly dampened wiping cloth to wipe the outside parts of the food processor.



#### Attention:

Do not rinse the food processor or its power cord under water or submerge it in water. Neither the stand nor the multi-function head are intended for washing in a dishwasher.

### BEATING, WHIPPING AND KNEADING PLANETARY MIXING SYSTEM

- The planetary mixing system is based on the principle of dual rotation of the attachment. The attachment rotates anticlockwise along the inner perimeter of the bowl while rotating around its own axis in the opposite direction. This ensures that ingredients inside the bowl are processed thoroughly and evenly.

### PREPARING FOR OPERATION



#### Warning:

Before you start assembling or disassembling the accessories of the food processor, check that it is turned off and disconnected from the power socket. Attaching an attachment while the multi-function head is connected to mains power, may result in it being accidentally turned on and serious subsequent injuries.

#### Selecting an attachment type

Attachment type	Operation
Balloon whisk <b>B1</b>	It is used for whisking whole eggs or egg whites, whipped cream, foamy creams, etc. Do not use it for beating or kneading doughs.
Beater <b>B2</b>	It is used for beating light and medium heavy yeast-free doughs, for preparing sauces, creams, cake mixes, fillings, etc. Do not use it for kneading heavy doughs.
Kneading hook <b>B3</b>	It is used for kneading various types of doughs including heavy and thick doughs such as for example bread dough, pizza dough, fresh pastry doughs, etc.
Elastic beater <b>B4</b>	It is used for beating dessert creams, instant puddings, mayonnaise, sponge cake dough, etc. Do not use it for kneading heavy doughs.

#### Adding ingredients into the bowl

- Put the ingredients that you wish to process into the stainless steel bowl. In a single batch, it is possible to process no more than 0.8 kg of heavy dough or 2.7 kg of light dough.
- The maximum number of egg whites that can be whisked at once is 8.
- We recommend filling the bowl no higher than the 4-litre level mark.
- If an insufficient amount of ingredients are put in the bowl (less than 0.3 litres of dough), then they may not be optimally processed.

#### Mounting attachments

- Place the food processor on an even, dry and stable surface, for example on a kitchen countertop.
- Press button **A10**. This will release the multi-function head. Tilt the multi-function head upwards all the way, so that a click is heard.
- If you wish to use the transparent anti-splash cover **A12** then you must attach it before mounting an attachment. Put the lid on the bottom side of the head with the shaft and turn it anticlockwise to secure it in place.
- Select an attachment and slide it on to the mounting shaft **A5**. Turn the attachment anticlockwise to secure it in position. Lightly pull the attachment downwards with one hand to check that it is properly attached.

#### Mounting the stainless steel bowl

- Insert the stainless steel bowl into the base unit **A6** and secure it in place by turning it clockwise. When the bowl is properly attached, it cannot be separately lifted out of the base.
- Use one hand to push down the button **A10** and the other to push down the head so that it clicks into place.

### OPERATION

- Connect the power cord to an el. power socket.
- Use the control knob to set the required speed level from 1 to 6. We recommend to start at a lower speed and to increase it gradually. You can change the speed setting even while the appliance is running. We recommend that runny doughs and sauces are processed at lower speed levels; this will prevent ingredients from splashing out. As soon as they are mixed together, increase the speed to the required level.



#### Attention:

Items such as spoons, kitchen knives, forks, etc. must not be placed into the appliance during operation as this could result in injury or damage to the appliance.

#### Releasing stuck-on ingredients

- In the event that an ingredient (e.g. dough) sticks to the edge of the bowl, turn off the food processor and disconnect it from the power socket.
- Tilt open the head. For better visibility into the bowl, it is possible to turn on the light by setting the control knob to position .
- Using an ordinary scraper, remove the stuck-on ingredient on the edge of the bowl and put it into the middle of the bowl.
- Tilt the head back into the operating position and reconnect it to mains power. Continue processing.

#### Operating time of the food processor

- When beating, whisking or kneading, do not leave the appliance in continuous operation for longer than 10 minutes.

- When kneading thick, heavy dough, do not allow the appliance to run for longer than 6 minutes.
- After one of the mentioned times has elapsed, turn off the appliance and allow it to cool down. The appliance can be used again after 30 minutes.

### Quick guide to processing ingredients

Attachment type	Ingredients	Speed	Processing time
Balloon whisk <b>B1</b>	Light mixtures (for example cream, egg whites, pudding, carrot)	5-6	4 min
Beater <b>B2</b> and elastic beater <b>B4</b>	Moderately heavy mixtures (for example cake dough, pancake mixes or sponge cake dough)	3-4	6 min
Kneading hook <b>B3</b>	Heavy mixtures (for example bread and pastry dough)	1-3	4-5 min



#### Note:

The above processing times are only a reference. To prevent ingredients from splattering out of the bowl, select an initial speed level of 1 or 2. Then set a higher

speed as required. For easier mixing of dough we recommended soft margarine or butter.

When whipping egg whites, the bowl and the beater must be perfectly clean and dry. Even a small amount of fat may result in that the egg whites will not be whipped to the desired snowy consistency.

Whipping cream should be cooled to a temperature of 6 °C prior to being whipped.

Prior to processing them, allow the ingredients used for making various doughs to rest at room temperature.

### ENDING OPERATION AND DISASSEMBLING THE ACCESSORIES

- After you have finished using the appliance, set the control knob to the 0 position (off) and disconnect the power cord from the power socket.
- Push down button **A10** and tilt the head upwards all the way, so that a click is heard.
- Turn the attachment clockwise to release it, and then remove it.
- Turn the stainless steel bowl anticlockwise and remove it from the base unit.
- Remove the transparent anti-splash cover **A12** by turning it clockwise.
- Tilt the head back down to the horizontal position.
- Clean out the food processor and the used accessories after each use according to the instructions in chapter CLEANING AND MAINTENANCE.

### BLENDING

#### USING THE BLENDER

- The blender is intended for preparing meals and drinks such as milkshakes, creamy soups, sauces, spreads, fresh baby foods, nutritional drinks, etc. It is not intended for juicing fruit and vegetables, preparing potato purée, yeast dough or for whipping egg whites.
- Either the blending jar **C3** (volume 1.5 litres) or smoothie jar **C6** (volume 0.6 litres) can be used for blending.

### ASSEMBLING THE BLENDER

#### Preparing the food processor for blending

- In order to be able to assemble and subsequently use the blender, it necessary to meet the following conditions:
  - place the food processor on an even, dry and stable surface, for example on a countertop.
  - the food processor must be disconnected from the power socket
  - the multi-function head must be tilted down into the horizontal position and no other attachment may be mounted on it
  - the stainless steel bowl must be mounted on the base unit
- Tilt open the cover **A8**. Underneath this cover there is a hub for mounting the blending or smoothie jar.

#### 1.5-litre blending jar – assembling and mounting (fig. F)

- Prior to putting on the blending jar on to the hub, first check that the base with the blade unit is correctly mounted in the jar.
- Place the blending jar on to the top hub and turn it clockwise to secure it in place. The safety mechanism will prevent the blender from starting unless the jar is correctly mounted on the hub.
- Place ingredients into the jar. We recommend cutting larger ingredients into smaller pieces before blending them.



#### Note:

Never fill the jar past the maximum mark.

When processing hot liquids or liquids that expand in volume during the blending process, it is recommended to fill the blending jar to no more than 2/3 of its maximum capacity.







- Seat the outer lid **C2** on to the blending jar and push it down so that it firmly adheres to the edges of the jar. Place the inner cap **C1** into the opening in the lid and secure it in place by turning it clockwise.

#### 0.6-litre smoothie jar – assembling and mounting (fig. G)

- The smoothie jar is intended for preparing fruit and vegetable smoothie drinks.
- Add the liquids and/or food that you wish to blend into the smoothie jar. Larger ingredients must be first cut into cubes measuring approximately 2 cm. Never fill the jar past the maximum mark.

- Place the base with the cutting assembly **C7** on to the neck of the jar so that the blades point into the jar, screw in the base and tighten securely.
- Turn the smoothie jar assembled in this way upside down so that the base with the blade assembly is underneath. Ensure that the base is securely attached and that nothing is leaking out of the jar.
- Place the smoothie jar on to the hub of the food processor and turn it clockwise all the way.

### QUICK GUIDE TO PROCESSING INGREDIENTS

Ingredients	Speed selection	Recommended blending time
Fruit, vegetables cut into smaller pieces	 or 5-6	30 s
Baby food	 or 5-6	40 s
Spreads, dressings, marinades	 or 5-6	30 s
Soups	 or 5-6	40 s
Smoothies and cocktails		30 s
Ice cubes		As necessary



#### Note:

The above food processing times are only a reference. The actual mixing time depends on the size of the ingredients, their amount and the required final consistency.

### ADVANCE AND TIPS FOR BLENDING

- First cut food with a firm consistency such as fruit and vegetables into smaller pieces measuring 3 cm and only then blend it.
- First, blend a smaller amount of ingredients and then gradually add more ingredients through the hole in the lid **C1** while blending. In this way, you will achieve better results than by adding all ingredients into the blending jar at once.
- If you need to blend food of a solid consistency together with liquids, we recommend that you first blend the food of solid consistency and a part of the liquids. Then gradually add the remaining liquids through the hole in the lid while blending.
- When blending very thick liquids, start the blender repeatedly in short interval bursts.
- Ice cubes must be processed immediately upon being removed from the freezer. When the ice starts to melt, the ice cubes will stick together and it will not be possible to blend them.

### BLENDING

- Check that control knob is set to position 0 (off). Connect the power cord to a power socket.
- Use the control knob to set the desired speed level or mode. We recommend to first set a slower speed to allow the ingredients to mix together. Then the speed may be increased.



#### Attention:

Do not process hot liquids that are hotter than 80 °C in the blending jar.

The maximum operating time of the blender is 2 minutes. Do not leave the food processor in continuous operation for longer than indicated above. After blending, allow the food processor to cool down for approx. 30 minutes.

The shaft of the head **A5** will move when the smoothie jar is used.

- If you wish to add more ingredients to the blending jar during the blending process, remove the inner cap **C1** and add the ingredients through the hole in the outer lid **C2**. However, never remove the outer lid while blending. When processing hot liquids, the inner cap **C1** must remain closed.

- In the event that food is sticking to the blade assembly or the walls of the blending jar, turn off the food processor by turning the control knob to the 0 position (off) and disconnect it from the power socket. Make sure that the blade assembly has stopped rotating. Carefully remove the jar from the multi-function head by turning it anticlockwise and pulling it upwards. Remove the lid and, using a spatula, clean the blade assembly and the walls of the blending jar. Put the lid back on and reattach the jar to the multi-function head. Plug the power cord into a power socket and continue blending.

## ENDING BLENDING AND DISASSEMBLING THE JARS

- After you have finished blending, set the control knob to the 0 position (off) and disconnect the power cord from the power socket. Before performing any other activity, check that the blade assembly inside the jar has stopped rotating.

### 1.5-litre blending jar – disassembly

- Release the blending jar by turning it anticlockwise and take it off by lifting it vertically upwards off the top hub.
- If you wish to prepare the blending jar for cleaning, pour the blended contents out into a suitable bottle or bowl, and wash out the blending jar using water and wipe it dry.
- Turn the blending jar upside down
- Use one hand to grasp the handle of the blending jar and with the other hand release the base with the blade assembly by turning it clockwise.
- In the event that it is not possible to release the base by hand, mount the blending jar back on to the hub of the food processor. Use one hand to hold the base with the blade assembly and the second hand to turn the blending jar anticlockwise. The blending jar should release and it should be possible to screw it off the base. After screwing off the blending jar, release the base from the hub. Put the hub cover back in its place.
- Clean the individual parts of the blending jar according to the instructions in chapter CLEANING AND MAINTENANCE.

### 0.6-litre smoothie jar – disassembly

- The smoothie jar must be removed from the food processor carefully so that the base with the blade assembly is not released from the neck of the jar, causing the contents to spill out.
- Release the jar by turning it anticlockwise and take it off by lifting it vertically upwards off the top hub. Put the hub cover back in its place.
- Turn the smoothie jar upside down so that the base with the blade assembly is on the top side.
- Screw the base out of the neck of the jar.
- Clean the individual parts of the smoothie jar according to the instructions in chapter CLEANING AND MAINTENANCE.

## GRINDING MEAT

### USING THE GRINDER

- The grinder is intended for grinding all types of meat that is free of bones, tendons and skin, and it can also grind fruit and vegetables. It also serves to make pasta, cookies and to stuff sausages.
- The grinder is not intended for crushing bones, nuts or other hard ingredients or frozen food.

## ASSEMBLING THE GRINDER

### Preparing the food processor for grinding

- In order to be able to assemble and subsequently use the grinder, it necessary to meet the following conditions:
  - place the food processor on an even, dry and stable surface, for example on a countertop.
  - the food processor must be disconnected from the power socket
  - the multi-function head must be tilted down into the horizontal position and no other attachment may be mounted on it
- Remove the cover **A2**. The front attachment hub for mounting the grinder is found underneath this cover.

### Assembling and mounting the grinder (fig. H)

- Insert the screw shaft **D2** into the grinding chamber **D11** with the cogged wheel entering first.
- Place the grinding blade **D3** on to the shaft (with the cutting edge facing outwards from the chamber) and on to it attach a grinding plate. Make sure that the notch in the grinding chamber slides into the groove in the grinding plate.



#### Attention:

When mounting the grinding blade, be very careful not to injure yourself on the sharp edge.

- Place the screw ring **D5** on to the grinding chamber and tighten it securely by screwing it clockwise.
- Tilt the assembled grinder to the right at an angle of 45°, push it against the front attachment hub **A4** and turn it anticlockwise to set it into the operating position. The operating position is indicated by button **A3** popping out and an audible click.



#### Note:

The food processor is equipped with a safety mechanism that prevents it from being started unless the grinder is properly mounted and secured on the front attachment hub.

- Seat the hopper **D9** on to the top feed tube of the grinder and place a suitable container underneath the grinder for capturing the processed food.

## GRINDING

- First prepare the meat for grinding in the following way: Remove all bones, tendons, cartilage and cut the meat into 2 × 2 × 6 cm size pieces that will freely pass through the top feed tube of the grinder.



#### Attention:

Do not process frozen meat. Allow it to defrost before grinding it.

- Check that control knob is set to position 0 (off). Connect the power cord to a power socket.
- Use the control knob to set the desired speed. We recommend to initially set speed 3 and then increase it as required. Gradually place the meat pieces into the feed tube and push them in using the pusher **D8**. Take care not to clog up the feed tube by a large amount of meat. Do not process more than 5 kg of meat per batch. The processing time is only several minutes.



#### Warning:

Do not use fingers or other items to push the meat in. Always use the pusher **D8** designed for this purpose.

The maximum operating time of the grinder is 6 minutes. Do not leave the food processor in continuous operation for longer than indicated above. After grinding, allow the food processor to cool down for approx. 30 minutes.

The shaft of the head **A5** will move during the grinding process.

- The ground meat will fall into the prepared bowl. The meat that remains in the grinding chamber can be removed by grinding a slice of bread or a bread roll.

## MAKING COOKIES, PASTA OR STUFFING SAUSAGES

- Proceed in the same manner as when assembling the grinder for grinding meat, only with the difference that, instead of the grinding blade, insert the pasta maker attachment **D11** or the sausage stuffer attachment **D12** or the cookie maker attachment **D13**.

## ENDING OPERATION AND DISASSEMBLING THE GRINDER

- After you have finished grinding, set the control knob to the 0 position (off) and disconnect the power cord from the power socket.
- Remove the hopper **D9**. Then press the button **A2** and remove the meat grinder by turning it clockwise and sliding it out of the hub. After removing the grinder, put the cover **A2** back in its place.
- When disassembling the meat grinder into its individual parts, proceed in the reverse sequence.
- Clean out the grinder and the used accessories after each use according to the instructions in chapter CLEANING AND MAINTENANCE.

## GRATING

### USING THE GRATER

- The grater is intended for grating practically all types of fruit and vegetables, cheeses, peeled nuts, cooking chocolate and similar foods that are normally used in the household.

## ASSEMBLING THE GRATER

### Preparing the food processor for grating

- In order to be able to assemble and subsequently use the grinder, it necessary to meet the following conditions:
  - place the food processor on an even, dry and stable surface, for example on a countertop.
  - the food processor must be disconnected from the power socket
  - the multi-function head must be tilted down into the horizontal position and no other attachment may be mounted on it
- Remove the cover **A2**. The front attachment hub for mounting the grater is found underneath this cover.

### Assembling and mounting the grater (fig. I)

- Insert a suitable grating cone (**E3** to **E6**) into the grating chamber.



#### Attention:

When inserting a cone into the grater, be very careful not to injure yourself on its sharp blades.

- Tilt the assembled grater to the right at an angle of 45°, push it against the front attachment hub **A4** and turn it anticlockwise to set it into the operating position. The operating position is indicated by button **A3** popping out and an audible click.



#### Note:

The food processor is equipped with a safety mechanism that prevents it from being started unless the grater is properly mounted and secured on the front attachment hub.

## GRATING

- Prepare the food and cut it into pieces that will pass through the top feed tube of the grater. Kernels and stones may need to be removed from certain types of fruit and vegetables.
- Place a suitable container underneath the grater for capturing the grated food.
- Check that control knob is set to position 0 (off). Connect the power cord to a power socket.
- Start by gradually placing ingredients into the feed tube. Use the supplied pusher to push ingredients through the feed tube **E1**.



### Warning:

Do not use fingers or other items to push in the food. Always use the pusher **E1** designed for this purpose. The shaft of the head **A5** will move during the grating process.

- Always insert the individual pieces of ingredients into the feed tube, and with appropriate force gently push down on the pusher. During operation, ensure that the ingredients are passing through the attachment by looking into the feed tube. Never fill the feed tube up to its top edge with ingredients. Processing large amounts of ingredients at once may overload the multi-function head of the food processor.

### Useful advice for grating

- To achieve the best possible results, process fresh not overly ripened fruit. The same applies to vegetables.
- Softer fruit such as strawberries can be put into the freezer for a few minutes prior to processing.
- Semi-hard cheese will be processed better if placed in a refrigerator over night or in a freezer for 30 minutes.
- We do not recommend processing soft or already grated cheese as this could clog up the feed tube.
- When using the fine grating cone or the slicing cone for long straight slices, push the ingredients through the feed tube gently. When using the coarse grating cone or the slicing cone for thick wavy slices, it is necessary to push the ingredients through with greater force.

## ENDING OPERATION AND DISASSEMBLING THE GRATER

- After you have finished grating, set the control knob to the 0 position (off) and disconnect the power cord from the power socket.
- When disassembling the grater, first remove the pusher. Then press the button **A2** and remove the grater by turning it clockwise and sliding it out of the hub. After removing the grinder, put the cover **A2** back in its place.
- When disassembling the grater into its individual parts, proceed in the reverse sequence.
- Clean out the grater and the used accessories after each use according to the instructions in chapter CLEANING AND MAINTENANCE.

## CLEANING AND MAINTENANCE



### Attention:

Prior to cleaning or maintenance, always disconnect the appliance from the power supply and allow it to cool down completely. The food processor and its tilt-out head and its power cord are not intended for washing in a dishwasher. Do not spray these parts with water or any other liquid or submerge them in water or any another liquid.

- After using it, thoroughly wash all parts that came into contact with food in hot water using neutral dishwashing detergent. Then rinse everything with clean water and allow to dry naturally or wipe dry thoroughly using a wiping cloth. After washing and drying, we recommend to coat the grinding blade **D3** and the grinding plate **D4** with cooking oil.
- If you whisked egg whites, first rinse the stainless steel bowl and the used whisk under cold water. If you were to use hot water, the egg white remains would harden and their removal would be more difficult.



### Attention:

The whisk and the beater attachments, the body of the meat grinder and the body of the grater are not intended for washing in a dishwasher. Other removable parts may be washed in a dishwasher. When washing the grinding blade and the blade assembly of the blending or smoothie jar take special care to avoid injury on the sharp cutting edges.

- Clean the blending jar **C3** or the smoothie jar **C6** by filling it with clean water and a few drops of kitchen detergent and then mounting it on the hub of the food processor and running it for 10 to 15 seconds. Then turn off the food processor, disconnect it from the power socket, and after the rotating parts have come to a stop, remove the jar. Empty out the contents of the jar and then thoroughly rinse it out with clean water and wipe it dry.
- Wipe the outer parts of the food processor and the multi-function head using a lightly dampened wiping cloth or sponge.



### Attention:

Never use chemicals, dishwashing wool, steel wool or cleaning agents with an abrasive component since these may seriously damage the surface of the food processor or the multi-function head.

## STORAGE

- Before storing it, the appliance and its accessories must be completely cool, turned off and disconnected from the power supply, clean and dry.
- Place the stainless steel bowl into the base on the stand and into it you can place the beater, whisk and kneading hood. Tilt the multi-function head to the horizontal position. Store the food processor and all the accessories in a clean, dry place out of children's reach.



### Attention:

Keep the stored food processor away from extreme temperatures, direct sunlight and excessive humidity and do not store it in an overly dusty environment. Do not place anything on to the stored food processor.

## TECHNICAL SPECIFICATIONS

Rated voltage range .....	220–240 V AC
Rated frequency .....	50/60 Hz
Rated power input .....	1,200 W
Volume of the stainless steel bowl .....	1.5 l
Volume of the glass blending jar .....	1.5 l
Volume of the smoothie jar .....	0.6 l
Electrical shock protection class .....	II
Noise level .....	85 dB(A)

The declared noise emission level of the appliance is 85 dB(A), which represents a level A of acoustic power with respect to a reference acoustic power of 1 pW.

### Explanation of technical terminology

Safety class for electrical shock protection:

Class II – Electrical shock protection is provided by double or heavy-duty insulation.

Changes to text and technical parameters are reserved.

## INSTRUCTIONS AND INFORMATION REGARDING THE DISPOSAL OF USED PACKAGING MATERIALS

Dispose of used packaging material at a site designated for waste in your municipality.

## DISPOSAL OF USED ELECTRICAL AND ELECTRONIC EQUIPMENT



This symbol on products or original documents means that used electric or electronic products must not be added to ordinary municipal waste. For proper disposal, renewal and recycling, hand over these appliances to determined collection points. Alternatively, in some European Union states or other European countries you may return your appliances to the local retailer when buying an equivalent new appliance.

Correct disposal of this product helps save valuable natural resources and prevents potential negative effects on the environment and human health, which could result from improper waste disposal. Ask your local authorities or collection facility for more details.

In accordance with national regulations penalties may be imposed for the incorrect disposal of this type of waste.

### For business entities in European Union states

If you want to dispose of electric or electronic equipment, ask your retailer or supplier for the necessary information.

### Disposal in other countries outside the European Union.

This symbol is valid in the European Union. If you wish to dispose of this product, request the necessary information about the correct disposal method from the local council or from your retailer.



This product meets all the basic requirements of EU directives related to it.